



REPLACEMENT FIBERGLASS BUCKETS

All parts are PCC manufactured replacements for specified brands.

Aerial Lift Buckets

24" x 24" x 39"

PCC Part # *Mount style - Controls - Step - Misc*

1101A410 Clamp Mount - Step Left - Angle Clips Left

1101C410 Clamp Mount - Step Right - Angle Clips Left



1101C410



1101C410



1101C410

Altec Buckets *(continued on next page)*

24" x 24" x 39"

PCC Part # *Mount style - Controls - Step - Misc*

1151A234 Fiberglass Rib 10-1/2" Between - Step Left - Controls Right

1151C233 Fiberglass Rib 10-1/2" Between - Step Right - Controls Left

1151S876 Thick Mount Wall - Walk-thru Left With Door - No Controls

24" x 24" x 40"

PCC Part # *Mount style - Controls - Step - Misc*

11152C216V Fiberglass Rib 18" Inside - Step Right - No Controls

1152A220 Fiberglass Rib 17" Outside - Step Left

1152C220 Fiberglass Rib 17" Outside - Step Right

1152C226 Fiberglass Rib 18" Inside - Step Right - No Controls



1151C233



1151C233



1152C220



1152X21X

Call for additional bucket configurations.

CALL TO ORDER 260-484-3139



REPLACEMENT FIBERGLASS BUCKETS

All parts are PCC manufactured replacements for specified brands.

Altec Buckets (continued)

24" x 24" x 42"	PCC Part #	Mount style - Controls - Step - Misc
	1153E246	Fiberglass Rib 8 5/8" Between - Lip 1-1/2" Wide Between Ribs Step Front - No Controls
	1153S876	Thick Mount Wall - 6-1/2" Holes 10" Horiz & 7" Vert Between Sets of Holes - Walk-thru Left - No Controls
24" x 30" x 42"	PCC Part #	Mount style - Controls - Step - Misc
	1156A210	Fiberglass Rib 18" Between - Step Left - Controls Front Duct Under Step
	1156A211	Fiberglass Rib 18" Between - Step Left - Controls Right 2"x 6"
	1156A216	Fiberglass Rib 18" Between - Step Left - No Controls
	1156A21C	Fiberglass Rib 18" Between - Step Left - Controls Between Ribs 2"x 6"
	1156B211	Fiberglass Rib 18" Between - 2 Steps Left - Controls Right 2"x 6"
	1156B21M	Fiberglass Rib 18" Between - 2 Steps Left - Controls Right 3-1/2"x10"
	1156B681	8 Stud Mount - Angle Clips Outside of Mount Studs - 2 Steps Left - Controls Right 2" x 6"
	1156BB19	Fiberglass Rib 18" Between - 2 Steps Left - Controls Right AL-1 3-1/2" x 10"
24" x 48" x 42"	PCC Part #	Mount style - Controls - Step - Misc
	1158A211	Fiberglass Rib 18" Between - Step Left - Controls Right 2"x 6"
	1158A216	Fiberglass Rib 18" Between - Step Left - No Controls
	1158A21C	Fiberglass Rib 18" Between - Step Left - Controls Between Ribs 2"x 6"
	1158A21N	Fiberglass Rib 18" Between - Step Left - Controls Right 3-1/2" x 10"
	1158A346	Steel Rib 8 3/4" Between - Step Left - No Controls
	1158B211	Fiberglass Rib 18" Between - 2 Steps Left - Controls Right 2" x 6"
	1158B212	Fiberglass Rib 18" Between - 2 Steps Left - Controls Between Ribs 2"x 6"
	1158B216	Fiberglass Rib - 18" Between - 2 Steps Left - No Controls
	1158B681	8 Stud Mount - 2 Steps Left - Controls Right 2" x 6"
	1158J211	Fiberglass Rib 18" Between - Step Left - Controls Between Ribs 2"x 6"
	1158J216	Fiberglass Rib 18" Between - Step Left - No Controls



1156A210



1156B681



1158A21C

Call for additional bucket configurations.

CALL TO ORDER 260-484-3139

All parts are PCC manufactured replacements for specified brands.

D Bucket

<i>PCC Part #</i>	<i>Mount style - Controls - Step - Misc</i>
1159G2LX	Fiberglass Rib - 2 Steps Mount Side Left of Ribs - Angle Clips 21" Right



1159G2LS

Dur-A-Lift

24" x 24" x 42"

<i>PCC Part #</i>	<i>Mount style - Controls - Step - Misc</i>
1253A210	Fiberglass Rib 9" Between - Step Left - No Controls
1253C210	Fiberglass Rib 9" Between - Step Right - No Controls
1253E210	Fiberglass Rib - 9" Between - Step Front
1253J210	Fiberglass Rib 9" Between - Step Left - No Controls
1253L210	Fiberglass Rib 9" Between - I/O Step Right - No Controls
1253P210	Fiberglass Rib 9" Between - Crawl-thru Left - ETI Controls Right
1253P21X	Fiberglass Rib 9" Between - Crawl-thru Left - No Controls
1253S211	Fiberglass Rib - 9" Between - Walk-thru Left - Door Hinge Left
1253X211	Fiberglass Rib 9" Between - Walk-thru Front - Door Hinge Left

24" x 30" x 42"

<i>PCC Part #</i>	<i>Mount style - Controls - Step - Misc</i>
1256J210	Fiberglass Rib 9" Between - Step Left
1256P21X	Fiberglass Rib 9" Between - Crawl-thru Left - No Controls
1256S211	Fiberglass Rib - 9" Between - Walk-thru Left - with Door



1253A210

Call for additional bucket configurations.

CALL TO ORDER 260-484-3139

All parts are PCC manufactured replacements for specified brands.

ETI

24" x 30" x 42"

PCC Part # *Mount style - Controls - Step - Misc*

1316J214 Fiberglass Rib 9" Between - Step Left - Controls Right

1316S321 Steel Rib 9 1/4" Between - Walk-thru Left with Door - Controls Right

Hidro Grubert

24" x 24" x 42"

PCC Part # *Mount style - Controls - Step - Misc*

1333A212 Fiberglass Rib 8" Between - Step Left - Angle Clips Both Sides

1333B213 Fiberglass Rib 8" Between - 2 Step Left - Angle Clips Right

1333P213 Fiberglass Rib 8" Between - Crawl-thru Left - Angle Clips Right

Hi-Ranger *(continued on next page)*

24" x 24" x 39"

PCC Part # *Mount style - Controls - Step - Misc*

1351A6N3 4 Stud Mount 18-1/2" Vert x 18" Horz - Step Left Terex P/N 453628

1351C6N3 4 Stud Mount 18-1/2" Vert x 18" Horz - Step Right

1351C6T1 4 Stud Mount 14-1/2"H x 13-3/4"V - Step Right - Controls Left 4 Stud 16"H x 113/4V

24" x 24" x 40"

PCC Part # *Mount style - Controls - Step - Misc*

1352C6N3 4 Stud Mount 18-1/2" Vert x 18" Horz (TEL-8) - Step Right

24" x 24" x 42"

PCC Part # *Mount style - Controls - Step - Misc*

1353A112 5F - Step Left - Controls Right

1353A121 5H - Step Left - Controls Right

1353A152 4E - Step Left - Controls Right



1351C6N3

Call for additional bucket configurations.

CALL TO ORDER 260-484-3139

All parts are PCC manufactured replacements for specified brands.

Hi-Ranger (continued)

24" x 30" x 42"

PCC Part # Mount style - Controls - Step - Misc

1356A1P4	6H Rotator Mount - Step Left - Controls Front
1356B112	5F - 2 Steps Left - Controls Right
1356B121	5/6 H - Steps Left - Controls Right
1356B182	4E - Steps Left - Controls Right
1356D111	5F - 2 Steps Right - Controls Left

24" x 48" x 42"

PCC Part # Mount style - Controls - Step - Misc

1358B112	5F - Steps Left - Controls Right
1358B122	5/6 G/H - Steps Left - Controls Right
1358B693	5TC - 4 Stud Mount 18" Horiz x 18-1/2" Vert - 2 Steps Left - No Controls
1358B1C2	6H 70/75 W/Hydraulic Leveling Steps Left Controls Right
1350F1G6	6TD - Step Left of Mount Side - Controls Right



1356A1P4



1358B112



1358B122



1358B1C2



1350F1G6

Call for additional bucket configurations.

CALL TO ORDER 260-484-3139



REPLACEMENT FIBERGLASS BUCKETS

All parts are PCC manufactured replacements for specified brands.

Holan & MTI

24" x 24" x 42"	PCC Part #	<i>Mount style - Controls - Step - Misc</i>
	1401J221	Fiberglass Rib 16" Between - Step Left - No Controls
	1403J221	Steel Rib 16" Between - Step Left - No Controls
24" x 30" x 42"	PCC Part #	<i>Mount style - Controls - Step - Misc</i>
	1466J213	Fiberglass Rib 8" between I/O Step Left Controls Right - U4



1466J213

Lift-All *(continued on next page)*

24" x 24" x 39"	PCC Part #	<i>Mount style - Controls - Step - Misc</i>
	14515265	LA-1 Mount - Step Right - No Controls
24" x 24" x 42"	PCC Part #	<i>Mount style - Controls - Step - Misc</i>
	14530081	4 Stud Mount with Control Mount LA-20 - Step Right
	1453C613	4 Stud Mount LA-1 - Step Right - Controls Front LA-3
24" x 30" x 39"	PCC Part #	<i>Mount style - Controls - Step - Misc</i>
	14540064	LA-17 Mount - Step Left - Controls Left of Mount on Mount Side LA-3

Call for additional bucket configurations.

CALL TO ORDER 260-484-3139

All parts are PCC manufactured replacements for specified brands.

Lift-All

24" x 30" x 42"

<i>PCC Part #</i>	<i>Mount style - Controls - Step - Misc</i>
14560985	4 Stud Mount LA-17 - Step Left - Controls Left of Mounting Studs LA-3
1456A381	Steel Rib 13" Between LA-15 - Step Left - Controls Right LA-3
1456A610	4 Stud Mount LA-1 - Step Left - No Controls
1456J388	Steel Rib 13" Between LA-15 - Step Left - Controls Right LA-3 (Offset to front)

24" x 48" x 42"

<i>PCC Part #</i>	<i>Mount style - Controls - Step - Misc</i>
14580074	Rib Mount LA-15 - Steps Left - Controls Right LA-18 - B17 3N 10050074
14580078	6 Stud Mount Offset Right LA-12 - Step Left - Controls Mount Side Centered LA-18
14582909	6 Stud Mount Offset Right LA-12 - Step Left - Control Mount Side LA-3 Controls Mount Side Centered
14582909	6 Stud Mount Offset Right LA-12 - Step Left - Control Mount Side LA-3 Controls Mount Side Centered
14584334	Steel Rib 13" Between Step Left - Controls Right LA-3
1458A320	Steel Rib 13" Between LA-15 - Step Left - Controls Right LA-3
1458A380	Steel Rib 13" Between LOM-502MS LA-15 - Step Left - No Controls
1458A675	6 Stud Mounting LA-12 - Step Left - Controls Mount Side LA-3
1458L695	4 Stud Mount LA-17 - Step Right - Controls Right of Mounting Studs LA-3



14560985



1456A610



1458A320

Mat-3

24" x 30" x 42"

<i>PCC Part #</i>	<i>Mount style - Controls - Step - Misc</i>
14862112	4 Tab Insert - 2 Step Left - Controls Right - No Sheave Guard Brackets

National Crane

24" x 24" x 42"

<i>PCC Part #</i>	<i>Mount style - Controls - Step - Misc</i>
1493X700	Thru Bolt Mounting Modified - Walk-thru Front

Call for additional bucket configurations.

CALL TO ORDER 260-484-3139



REPLACEMENT FIBERGLASS BUCKETS

All parts are PCC manufactured replacements for specified brands.

Pitman

24" x 24" x 42"	PCC Part #	Mount style - Controls - Step - Misc
	1503A201	Fiberglass Rib 9" Between - Step Left - No Controls
	1503C201	Fiberglass Rib 9" Between - Step Right - No Controls

Posi Plus

24" x 30" x 39"	PCC Part #	Mount style - Controls - Step - Misc
	1534A211	Fiberglass Rib 20 1/4" Between - Step Left - No Controls

Reach-All

24" x 48" x 42"	PCC Part #	Mount style - Controls - Step - Misc
	1558G305	Steel Rib Low Mount RA-5 2 Hole - 2 Steps Mount Side - No Controls
	1558G315	Steel Rib RA-5- 2 Steps Mount Side - No Controls
	1558G337	High Mount RA-7 - 2 Steps Mount Side - No Controls
	1558G368	Steel Rib Low Mount RA-8 2 Hole - 2 Steps Mount Side - RA-3 Controls Left

Skyworker

24" x 24" x 39"	PCC Part #	Mount style - Controls - Step - Misc
	1681C312	Steel Rib SKY-2 9 1/8" Between Step Right Controls Left



1681C312

TECO (continued on next page)

24" x 24" x 42"	PCC Part #	Mount style - Controls - Step - Misc
	1803A111	Regular Mount - Step Left - Controls Front - Duct Cover Right
	1803A119	Regular Mount - Step Left - Controls Front - Hose Cover Left (Above Step)
	1803A122	Dump Mount - Step Left - No Controls
	1803C111	Regular Mount - Step Right - Controls Front - Duct Cover Left
	1803C114	Regular Mount - Step Right - Controls Front - Open Duct Left
	1803C122	Dump Mount - Step Right - No Controls
	1803C124	Dump Mount - Step Right - Controls Front - Duct Cover Left

Call for additional bucket configurations.

CALL TO ORDER 260-484-3139

All parts are PCC manufactured replacements for specified brands.

TECO

24" x 30" x 42"	PCC Part #	Mount style - Controls - Step - Misc
	1806C125	Dump Mount - Step Right - Controls Left of Mout
24" x 48" x 42"	PCC Part #	Mount style - Controls - Step - Misc
	1808A1P3	Vanguard - TEC-20 W/ Separate Sheave Guard - Step Left - Controls Right

Terex-Telelect

24" x 24" x 42"	PCC Part #	Mount style - Controls - Step - Misc
	1853J664	4 Stud Mount 16-3/4" H x 13-3/4" V TEL-9 - Step Left - Controls Right 16" H x 10-3/4" V TEL-12
	1853J692	4 Stud Mount 18" Horiz x 18-1/2" Vert TEL-8 - Step Left - No Controls
24" x 30" x 42"	PCC Part #	Mount style - Controls - Step - Misc
	1856A664	TL 38P - 4-5/8" Stud Mount 16-3/4" Horiz x 13-3/4" Vert - Step Left - Controls 4-3/8" Studs 16" Horiz x 10-3/4" Vert
	1856A692	4 Stud Mount 18" x 18-1/2" - Step Left - No Controls
	1856A6M7	4 Stud Mount 18" x 28 -/16" - Step Left - Controls Right TEL-16
	1856B6N2	4 Stud Mount 18" Horiz x 18-1/2" Vert - 2 Steps Left - Controls Right HR
	1856E6R2	4 Stud 14-1/2" Horiz x 14" Vert - Step Front Offset Right
	1856J664	4 Stud Mount TEL-9 - Step Left - Controls Right 4 Stud TEL-12
24" x 48" x 42"	PCC Part #	Mount style - Controls - Step - Misc
	1858A6M3	5TC 4 Stud Mount TEL-8 - Step Left - No Controls
	1858B692	4 Stud Mount TEL-8 18" Horiz x 18-1/2" Vert - 2 Steps Left - Controls Right HR
	1858B693	4 Stud Mount TEL-8 18" Horiz x 18-1/2" Vert - 2 Steps Left - No Controls



1853J692



1856B6N2



1856E6R2



1858A6M3

Call for additional bucket configurations.

CALL TO ORDER 260-484-3139



REPLACEMENT FIBERGLASS BUCKETS

All parts are PCC manufactured replacements for specified brands.

Telsta

24" x 24" x 42"

PCC Part # Mount style - Controls - Step - Misc

1903P521	Shaft Mount TELS-2 - Crawl-thru Left - No Controls
1903S510	Shaft Mount TELS-2 - Walk-thru Left W/ Door - No Controls.
1903X510	Shaft Mount TELS-2 - Walk-thru Front W/ Door - No Controls



1903P521

Identify your Telsta Shaft Mount

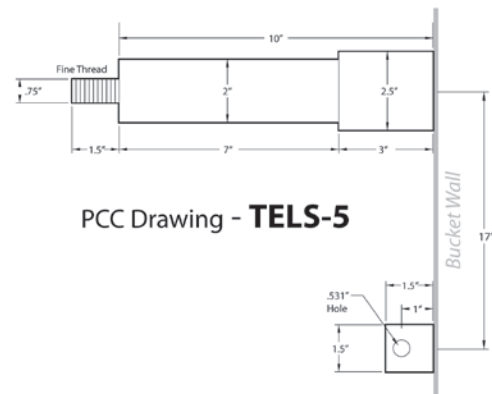
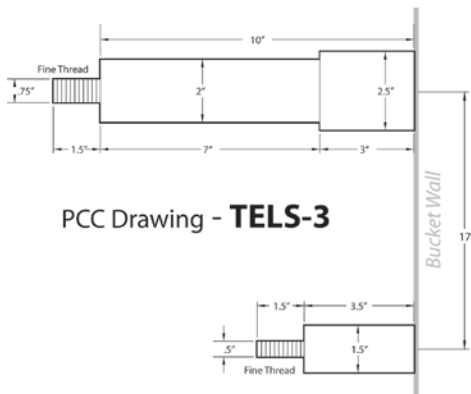
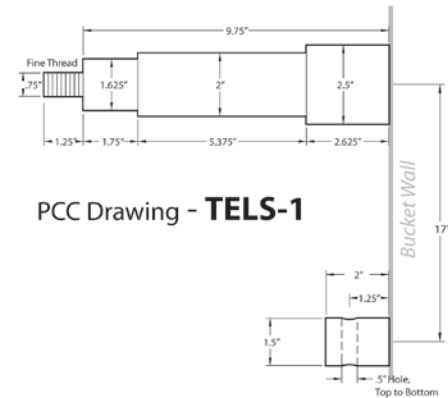
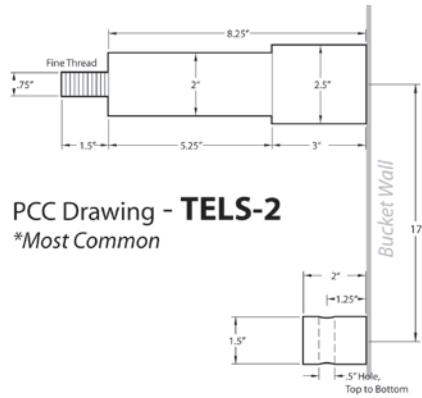

Call for additional bucket configurations.

CALL TO ORDER 260-484-3139

All parts are PCC manufactured replacements for specified brands.

U-Tem

24" x 24" x 42"

<i>PCC Part #</i>	<i>Mount style - Controls - Step - Misc</i>
1943J211	Fiberglass Rib - 9" Between - Step Left

Versalift *(continued on next page)*

24" x 24" x 39"

<i>PCC Part #</i>	<i>Mount style - Controls - Step - Misc</i>
1951C318	Steel Rib 8" Between - Step Right - Controls Left VER-8

24" x 24" x 42"

<i>PCC Part #</i>	<i>Mount style - Controls - Step - Misc</i>
1953A215	Fiberglass Rib 8" Between 2-1/2" Deep - Step Left - Controls Right VER-8
1953A219	Fiberglass Rib 8" Between 2-1/2" Deep - Step Left - No Controls
1953A21L	Fiberglass Rib 8" Between 2-1/2" Deep - Step Left - Controls Right VER-10
1953C210	Fiberglass Rib 8" Between - Step Right - No Controls
1953C212	Fiberglass Rib - Step Right - Controls Left Ver-10
1953C213	Fiberglass Rib 8" Between - Step Right - Controls Left (VER-8) Nuts
1953C215	Fiberglass Rib 8" Between - Step Right - Controls Left - Angle Clips
1953C21A	Fiberglass Rib 8" Between - Step Right - Controls Left VER-10
1953E21L	Fiberglass Rib 8" Between 2-1/2" Deep - Step Front - Controls Right VER-10
1953J214	Fiberglass Rib 8" Between 2-1/2" Deep - Step Left - Controls Front VER-9
1953J219	Fiberglass Rib 8" Between - Step Left - No Controls
1953J21P	Fiberglass Rib 8" between ribs, Step Left Ver-10 Control Front Hose Cover Bracket Right



1953C21A

Call for additional bucket configurations.

CALL TO ORDER 260-484-3139



REPLACEMENT FIBERGLASS BUCKETS

All parts are PCC manufactured replacements for specified brands.

Versalift

24" x 24" x 42"

PCC Part #	Mount style - Controls - Step - Misc
1953P210	Fiberglass Rib 8" Between - Crawl-thru Left - No Controls
1953P215	Fiberglass Rib 8" Between - Crawl-thru Left - Angle Clips Right
1953P310	Fiberglass Rib 8" Between 2-1/2" Deep - Crawl-thru Left - No Controls
1953P600	L Shape Mount - Crawl-thru Left - No Controls
1953Q215	Fiberglass Rib 8" Between - Crawl-Thru Right - Controls Left - Angle Clips
1953S210	Fiberglass Rib 8" Between 2-1/2" Deep - Walk-thru Left - No Controls
1953S740	L Shape Mount - Walk-thru Left W/ Door - No Controls
1953X31P	Steel Rib 8" Between 2-1/2" Deep - Walk-thru Front with Door - Controls Right - VER-9
1953X600	L Shape Mount - Walk-thru Front with Door - No Controls

4" x 30" x 42"

PCC Part #	Mount style - Controls - Step - Misc
1956A210	Fiberglass Rib 8" Between - Step Left - Controls Right VER-10
1956A213	Fiberglass Rib 8" Between - Step Left - Controls Right VER-8
1956J21L	Fiberglass Rib 8" Between - I/O Step Left - Controls Right VER-10
1956L215	Fiberglass Rib 8" Between - Step Right - Angle Clip Controls Left
1956N21L	Fiberglass Rib 8" Between - Step Front - Controls Left VER-10

24" x 48" x 42"

PCC Part #	Mount style - Controls - Step - Misc
1958A21L	Steel Rib 8" Between - Step Left - Controls Right VER-10
1958A283	Steel Rib 8" Between - Step Left - Controls Right VER-8
1958B283	Steel Rib 8" Between - 2 Steps Left - Controls Right VER-8
1958B28A	Steel Rib 8" Between - 2 Steps Left - Controls Right VER-10
1958J215	Steel Rib 8" Between - I/O Step Left - Controls Right VER-8
1958J26L	Steel Rib mount - 18 between ribs. I/O step left, VER-10 controls right
1958K218	Steel Rib 8" Between - I/O Steps Left - Controls Right VER-10



1953P600

Call for additional bucket configurations.

CALL TO ORDER 260-484-3139

All parts are PCC manufactured replacements for specified brands.

MORE Brands Available - Call to order one of the following buckets:

- Altec Reach-All
- Texoma
- Mat-3
- Posi Plus
- Aerolift
- Armlift
- Hidro Grubert
- Skyjacker
- Skymaster
- SkyVan
- Strato
- Stelcoi

Identify Your Bucket Truck Type:



Standard Mount



Reverse Mount

Call for additional bucket configurations.

CALL TO ORDER 260-484-3139

All parts are PCC manufactured replacements for specified brands.

Customize Any Bucket with Options

<i>PCC Part #</i>	<i>Description</i>
6151X100	4" hose tunnel installed (Altec)
63211000	Additional 4" x 14" step installed
63211100	6" x 15" step in place of standard step installed
63211200	Inside/outside step installed in place of standard step
63211300	Inside/outside step installed in addition to standard step
63211400	24" Toe Space
63211500	30" Toe Space
63211600	48" Toe Space
63212050	Walk-thru with metal frame
63212150	Door, hardware & installation of door for walk-thru bucket
63212300	Heater pouch in bucket side installed
63213110	Non-slip floor surface 24" x 24" bucket installed
63213120	Non-slip floor surface 24" x 30" bucket installed
63213130	Non-slip floor surface 24" x 48" bucket installed



Call for additional bucket configurations.

CALL TO ORDER 260-484-3139

All parts are PCC manufactured replacements for specified brands.

Still having trouble locating the right bucket?

If you were unable to find your exact bucket, we can build a replacement bucket to match your damaged one. Please take a few moments to fill out the worksheet below to help us build the correct bucket for you.

1. AERIAL MANLIFT:

Manufacturer _____ Model # _____ Mfg. Part # _____

2. DESIRED COLOR:

Our standard is white interior white exterior. Other colors available upon request at an additional charge.
 Inside _____ Outside _____

3. BUCKET SIZE:

- A. Length _____
- B. Width _____
- C. Height _____

For LENGTH and WIDTH, measure inside dimensions at top. For HEIGHT, measure from bottom of inside to top lip.

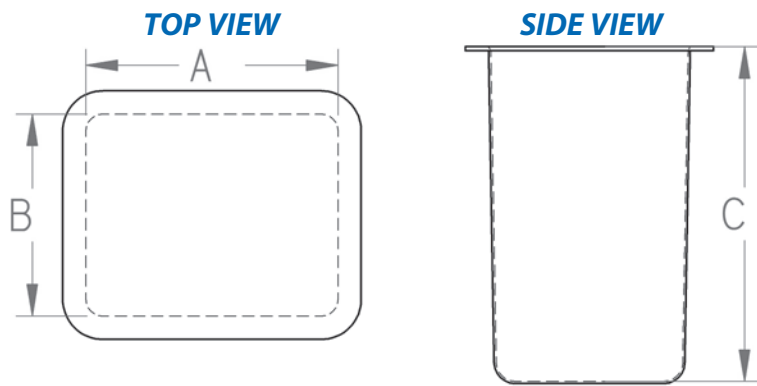

4. MOUNT TYPE: (circle one)

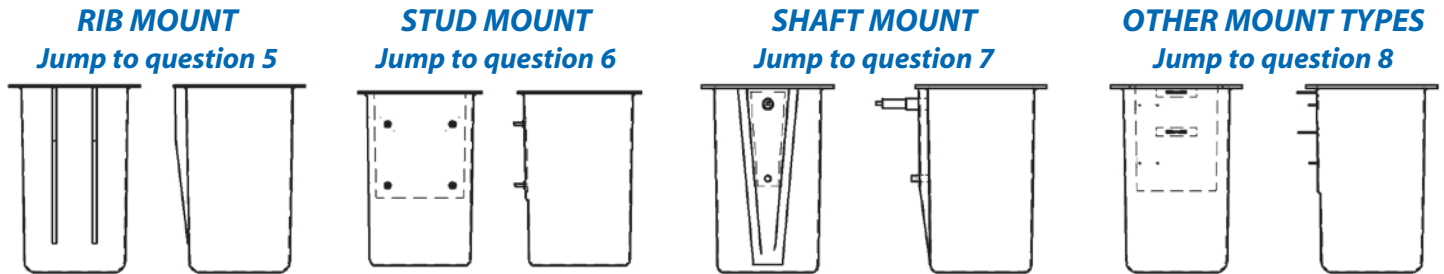

5. RIB MOUNT:

- A. Which dimension is critical? (check one)
 - The interior of the ribs? The exterior of the ribs? Interior of one rib to the exterior of the other?
- B. What is that critical dimension? _____
- C. How far out do the ribs protrude from the wall of the bucket?
 - At the top? _____ At 24" from the top of the rib? _____
 - And, how long are they? _____

CALL TO ORDER 260-484-3139

5. RIB MOUNT:

D. Many customers prefer to drill the mounting holes in the ribs themselves. Do you wish to drill them yourself?

YES or **NO** (circle one)

If NO and you wish for us to drill the holes, please use the diagram to the right to sketch hole size and location. If rib shape is different than what is shown, please sketch it as well.

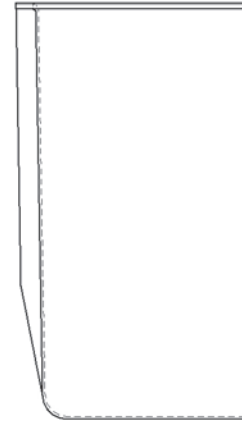

E. Are there other items on the rib side, such as angles or studs for a guard?

YES or **NO** (circle one)

If YES, please use the diagram to the right to sketch dimension and location.

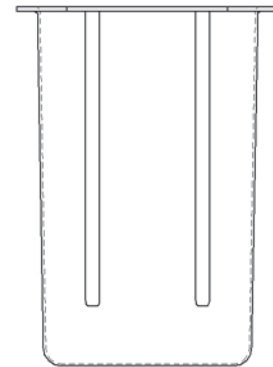

F. JUMP TO QUESTION 9.

6. STUD MOUNT:

A. Please sketch stud location on diagram

What is the stud diameter? _____

What is the type of thread? _____

What is the length of stud from bucket wall? _____

MOUNT SIDE

SIDE VIEW

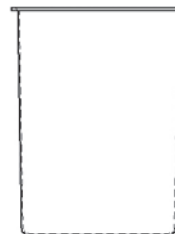

B. Are there other items on the mount side, such as angles or studs for a guard?

YES or **NO** (circle one)

If YES, please use the diagram to the right to sketch dimension and location.

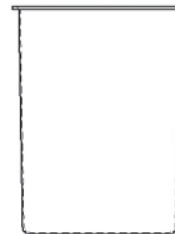

F. JUMP TO QUESTION 9.

CALL TO ORDER 260-484-3139

7. SHAFT MOUNT:

A. What type of shaft mount do you have? (Asplundh, Telsta, Aerial Lift of CT, Skyworker, etc.)

B. If you have an Aerial Lift of CT, we require the clamp from your existing bucket.

C. Are there other items on the mount side, such as angles or studs for a guard?

YES or **NO** (circle one)

If YES, please use the diagram to the right to sketch dimension and location.

D. JUMP TO QUESTION 9.

MOUNT SIDE

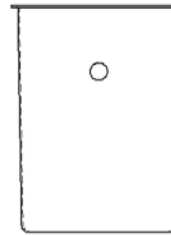

SIDE VIEW

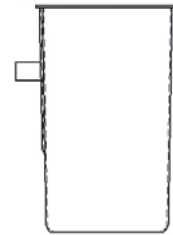

8. OTHER MOUNT TYPES:

A. Please sketch the mount and dimensions on the diagram to the right.

B. Are there other items on the mount side, such as angles or studs for a guard?

YES or **NO** (circle one)

If YES, please use the diagram to the right to sketch dimension and location.

F. JUMP TO QUESTION 9.

MOUNT SIDE

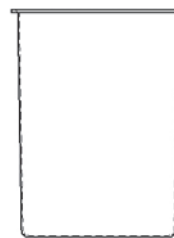

SIDE VIEW



All parts are PCC manufactured replacements for specified brands.

9. WHAT IS ON EACH SIDE OF THE BUCKET?

Picture yourself standing in the bucket with your back to the boom. Looking at each side of your bucket, please sketch the location and dimensions of any steps, control mounting, toe spaces, etc. on the diagrams below.

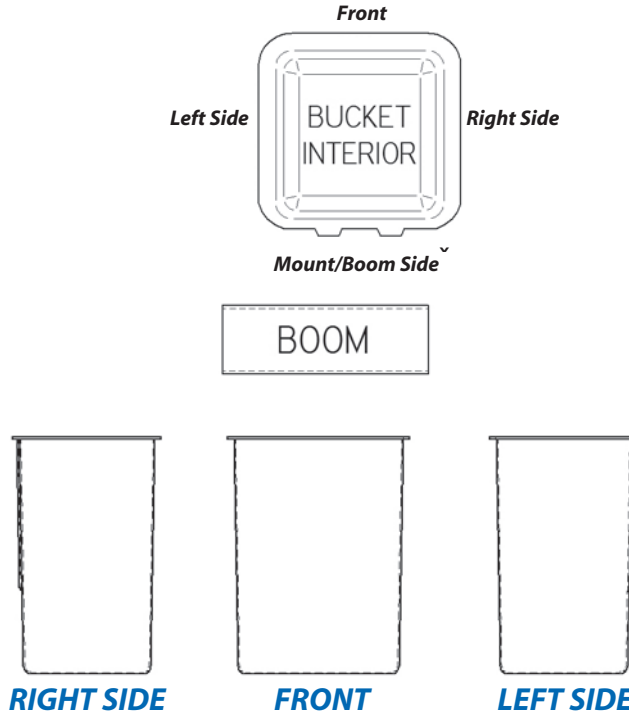

10. STEPS:

Do you need inside/outside step(s)? _____
 (Keep in mind, if you use a liner there is no need for an inside step.)

11. WALK-THRU OR CRAWL-THRU:

Do you require a walk-thru or crawl-thru? (Telephone/cable buckets only)

A. **WALK-THRU** or **CRAWL-THRU** (circle one)

B. Door? **YES** or **NO** (circle one)

If YES, as you face the door from the outside, is the door hinge on the **LEFT** or **RIGHT**? (circle one)

12. EXTRAS:

Do you require any other extras that have not been covered to be added to your bucket?
 (See page 21 of this catalog for a complete list of options)

CALL TO ORDER 260-484-3139